



G2 LED STADIUM LIGHTING

400W, 500W, 600W, 800W, 1000W, 1200W

FEATURES

- Very low windage area (EPA)
- Only 442mm in diameter can easily replace HID / MH / HPS fixtures on existing poles, wiring and mounting arms
- One PCB board design, better glare control with our quality Lens
- Light weight design ensures less force on poles
- Unique hollow design for excellent heat dissipation

DIMENSION & WEIGHT

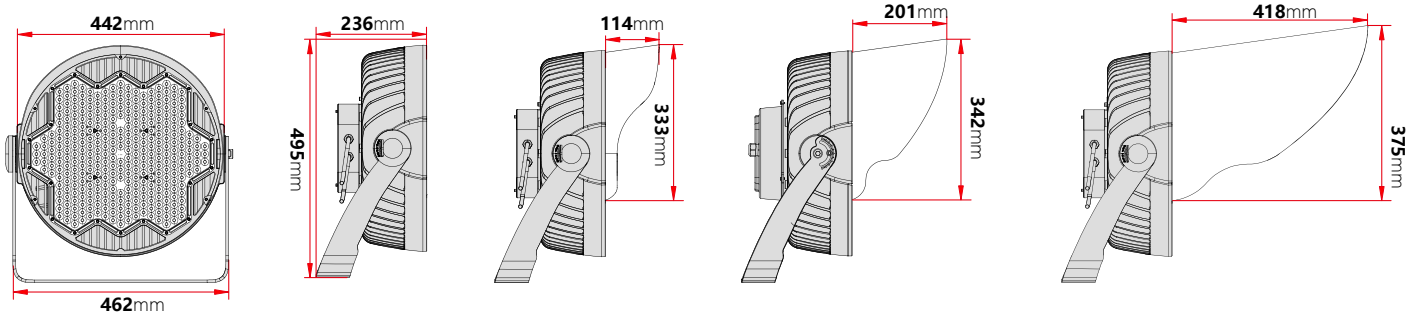

FIXTURE WEIGHT : 24 kg (Remote Drivers) / 33 kg (With Drivers)

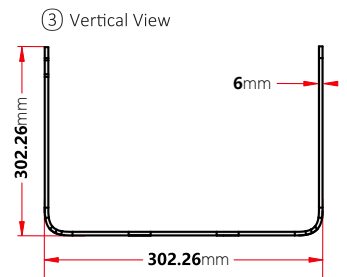
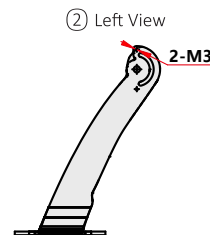
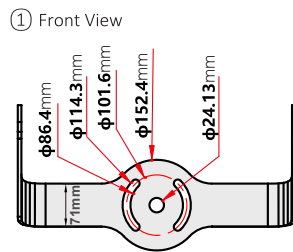
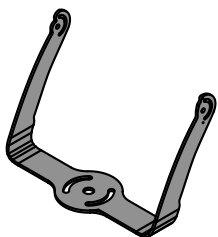

- Standard thickness for the U-Bracket is 6mm, other thickness need to be customized.

PHOTOMETRICS

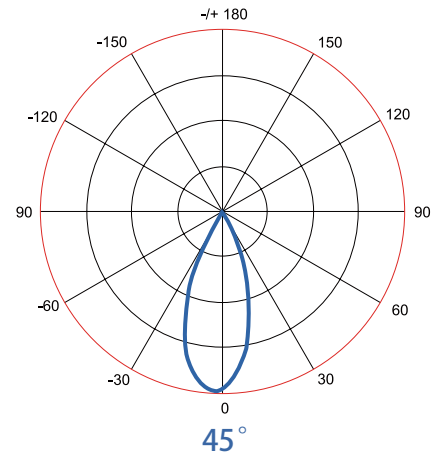
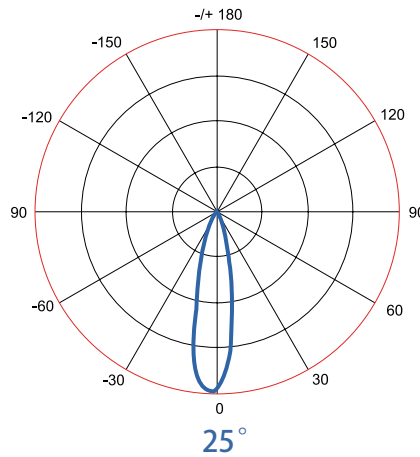
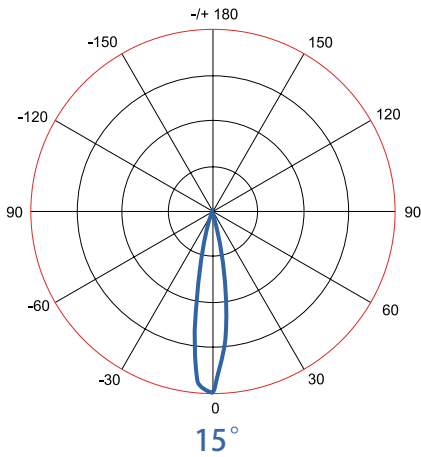

ORDERING INFORMATION

EXAMPLE PART #: ST-RSL - 400 - NICHIA - MEANWELL - 3K-70-15° - 100/277V

ST-RSL							
SERIES	WATTS	LED LIGHT SOURCE	DRIVER	CCT	CRI	LENS	INPUT POWER
ST-RSL	400	NICHIA	MEANWELL	3K-3000k	70	15°	100-277V
	500	OSRAM	INVENTRONICS	4K-4000k	80	25°	180-528V (Optional)
	600			5K-5000k	90	45°	
	800			5.7K-5700k			
	1000			6.5K-6500k			
	1200						

SPECIFICATIONS

Beam Angle | 15° / 25° / 45°

Lumen Output | 48,000LM / 60,000LM / 72,000LM
96,000LM / 120,000LM / 144,000LM

OPERATING TEMPERATURE | -40°C to 50°C

IP RATING | Standard with IP 65, IP66 is optional

LIFE TIME | 50,000hours

LISTINGS

ETL Listed

DLC Listed

Other Details

Fixture Material | Aluminum

Mounting | Standard with U-Bracket, Slip Fitter and other
adpters/arms can be customized

Color | Standard with Grey, Other colors can be customzied
after confirmed RAL number

Warranty | Standard with 5 years, 7 / 10 Years can be customzied

EPA | 0.058 m² — 0.138 m²

Jiaying Shinetoo Lighting Co.,Ltd(China Factory)

Add:No.258, Xingchang Road, Xincheng Town, Xiuzhou District, Jiaying, Zhejiang, China 314015
Tel : +86-573-83350-0001 Fax : +86-573-83350-0005
Mobile : +86-138-0961-6725/+86-138-1878-3129
Email:Sales@stledlights.com

SPARE PARTS (Order accessories as separate part number from your Fixture Model No.)



VGS: Visor Glare Shield



Remote Drivers

Distance from Luminaire May Not Exceed 100' .
Standard Remote Driver Distance from Luminaire is 6'
unless Otherwise Specified.



Adapters

NOTE: We can customize different
types adapters and arms.

Visors



Come standard with type 1 Visor, other types need to be customized.

ADJUSTABLE MOUNT

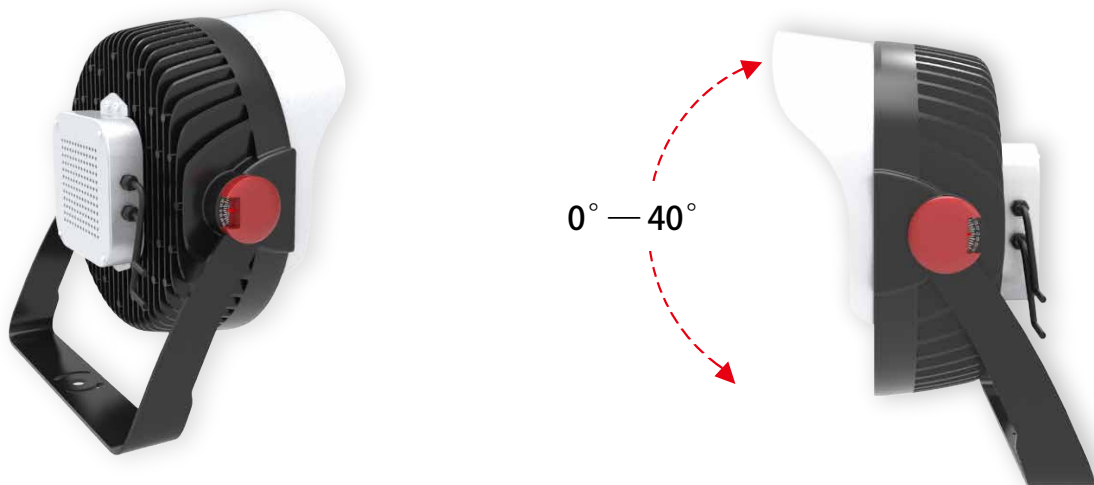

Adjustable loop mounting bracket rotates 0° —40° for convenient optical control and
easy replacement of existing fixture installations.

Jiaying Shinetoo Lighting Co.,Ltd(China Factory)